

THIS IS A C.A.D. GENERATED DRAWING
DO NOT MAKE MANUAL REVISIONS TO MASTER.

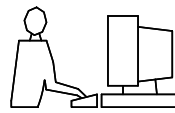

* UNLESS OTHERWISE SPECIFIED TOLERANCES
ON DECIMAL IS: ANGLE $\pm 3^\circ$
UNIT: MM X ± 0.50
X.X ± 0.38
X.XX ± 0.25
X.XXX ± 0.10

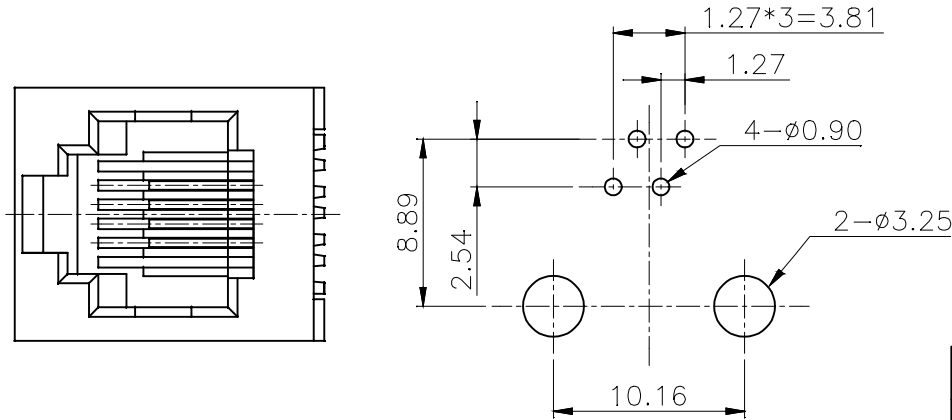

PCB LAYOUT/TOP VIEW

Ordering information:

Type	P/N-BULK	Product Code
6P4C-V-Unshielded	2101-0110-14	MHRJJ64NFV

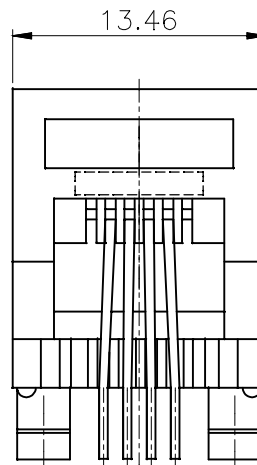
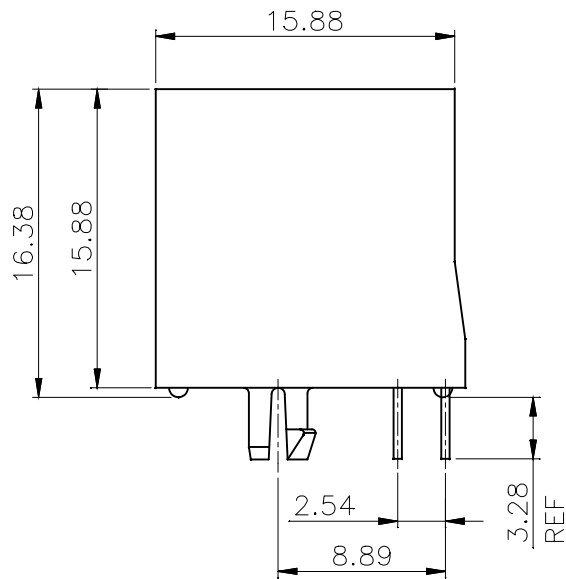

MATERIALS:

1. PLASTIC HOUSING: ENGINEERING THERMOPLASTIC
FLAMMABILITY RATING UL 94V-0.
2. CONTACTS: 0.46MM DIAMETER PHOSPHOR BRONZE.
3. PLATING: GOLD PLATING OVER NICKEL.

THESE DRAWINGS AND SPECIFICATIONS ARE THE PROPERTY OF MH CONNECTORS LTD. AND SHALL NOT BE REPRODUCED, COPIED OR USED AS THE BASIS FOR THE MANUFACTURE OR SALE OF APPARATUS WITHOUT WRITTEN PERMISSION.

DRAWN	DATE
HALEY	11-18-13

APPROVED	DATE
DAMIEN	11-19-13

SCALE	SHEET OF	REV:
	1 OF 1	4.0

DRAWING No
MHRJJ64NFV



THIS SERIES FULLY CONFORMS TO THE EUROPEAN UNION DIRECTIVES 2002/95/EC AND 2002/96/EC FOR RoHS COMPLIANCY.



MH CONNECTORS LTD.