



E. HARTNER & CO

<https://www.ehartner.at/>

 **binder**

NEWS



www.binder-connector.de



Contents

Range	Description	Series	Page
-------	-------------	--------	------

SUBMINIATURE

Snap-in IP67	Safety clip	620	6–7
NCC IP67	Cable and panel-mount connectors	670	8–9

MINIATURE

Snap-in IP67	Safety clip	720	12–13
NCC IP67	Moulded cable connectors	770	14–15
M16 IP67	Cable connectors, short version, shieldable	423	16–17

AUTOMATION TECHNOLOGY Sensors & Actuators

M8	Moulded snap-in cable connectors with 5 and 6 contacts	718	20–21
M8	Moulded and shielded male cable connector	718	22–23
M12-A	Lead-through for control cabinets	713	24–25
M12-A	Rectangular male panel-mount connectors 20 and 26 mm	713 · 763	26–27

AUTOMATION TECHNOLOGY Data Transmission

M8-D	Field-attachable, moulded and panel-mount connectors	818	30–33
------	--	-----	-------

AUTOMATION TECHNOLOGY Voltage & Power Supply

M12-S/-K/-T/-L	Lead-through for control cabinets	814 · 824 · 813 · 823	36–37
M12-K/-L	Cable connectors according to UL 2237	824 · 823	38–41
M12-L	Panel-mount connectors two-part design	823	42–43

**SUB
MINI
ATURE**

Snap-in

Series	620
Number of lugs	3
Material	PA
Connection	Snap



620 Series • Snap-in safety clip

- Accessories 620 series snap
- Three snap tabs
- High retention force
- Black colour. White upon request
- Marking for easy assembly
- Lockable with cable tie
- Reusable
- Packaging unit 10 pcs.
- Available

Description	Drawing	Ordering-No.
Safety clip		08 0219 000 000

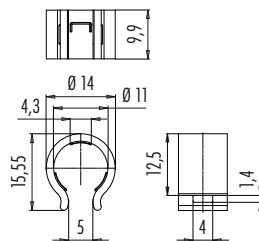



Bayonet NCC

Series	670
Contacts	5
Rated current	2 A
Rated voltage	50 V
Degree of protection	IP54 female panel-mount connector in unmated condition, IP67 in mated condition
Contact plating	Au (gold)
Termination	solder, dip solder



670 NCC Series • Cable and panel-mount connectors

- Male cable connector with 3-5 mm cable outlet
- Panel-mount connectors with solder and dip solder contacts
- Panel-mount connectors in unmated condition IP54
- IP67 in mated condition
- Panel-mount connectors with front or rear fastening
- > 1000 mating cycles
- Bayonet locking system
- Available



Description	Drawing	Contacts	Ordering-No.
Male cable connector		5	99 0759 010 05

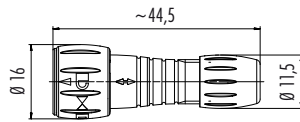

Female panel-mount connector, solder/dip solder

solder

dip solder

5

09 0762 000 05 solder
09 0762 090 05 dip solder

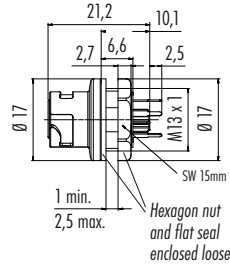
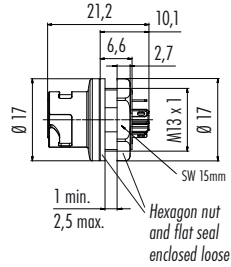

Female panel-mount connector, front fastened, solder/dip solder

solder

dip solder

5

09 0762 180 05 solder
09 0762 190 05 dip solder

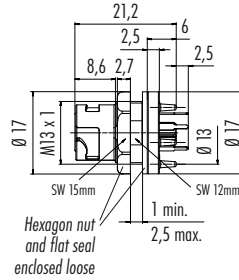
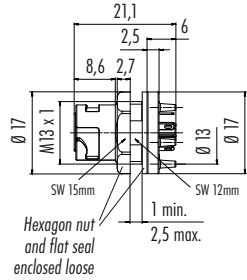

Assembly instruction

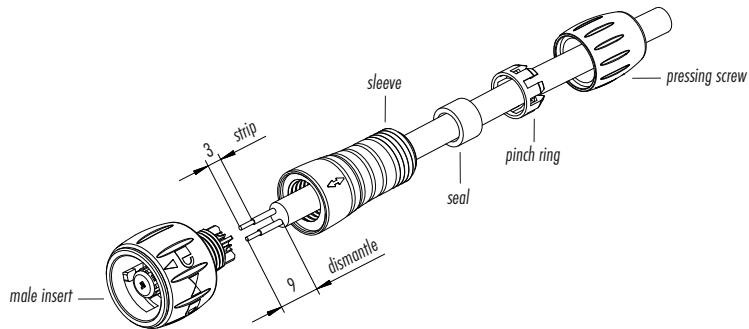

Contact arrangements

Male insert (termination side)

Female insert (termination side)

Panel cut out

Drilling schemes

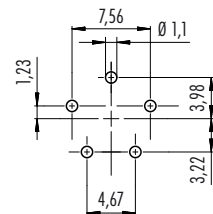
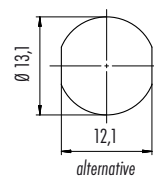
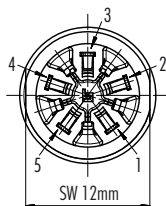

**MINI
ATURE**

Snap-in

Series	720
Number of lugs	3
Material	PA
Connection	Snap



720 Series • Snap-in safety clip

- Accessories 720 series snap
- Three snap tabs
- High retention force
- Black colour. White upon request
- Marking for easy assembly
- Lockable with cable tie
- Reusable
- Packaging unit 10 pcs.
- Available

Description

Safety clip

Drawing

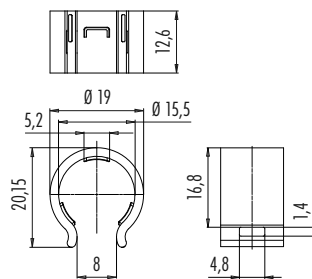

Ordering-No.

08 0216 000 000





Bayonet NCC

Series	770
Contacts	8
Rated current	2 A
Rated voltage	175 V
Design	With bayonet ring in black Colour upon request
Degree of protection	IP67 in mated condition
Contact plating	Au (gold)
Termination	PVC/PUR cable



770 NCC Series • Moulded male cable connectors

- Connectors moulded on cable
- Straight version
- PVC and PUR cable
- Black, colour upon request
- IP67 in mated condition
- > 5000 mating cycles
- Bayonet locking system
- Standard cable length 2 m and 5 m
- Other lengths upon request
- Available

Description

Cable connector, moulded, black



Drawing

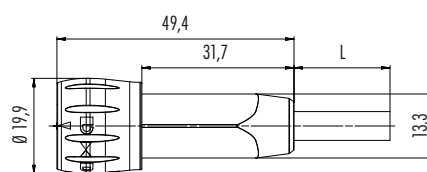

Contacts Cable Cable length Ordering-No.

Contacts	Cable	Cable length	Ordering-No.
8	PVC	2 m	77 6005 0000 20008-0200
		5 m	77 6005 0000 20008-0500
	PUR	2 m	77 6005 0000 50008-0200
		5 m	77 6005 0000 50008-0500





M16 IP67

Series	423
Contacts	2-19
Rated current	3-7 A
Rated voltage	32 V / 150 V
Cable outlet	4.1-7.8 mm
Degree of protection	IP67 in mated condition
Contact plating	AG (silver), Au (gold)
Termination	solder, crimp



423 Series • M16 Cable connectors, short version, shieldable

- Product launch 423 series
- Shieldable with cable clamp
- Cable outlet 4.1 – 7.8 mm
- Length approx. 47 mm
- > 500 Mating cycles
- IP67 in mated condition
- Solder and crimp connection
- Crimp contacts must be ordered separately
- Other pole numbers on request
- Available

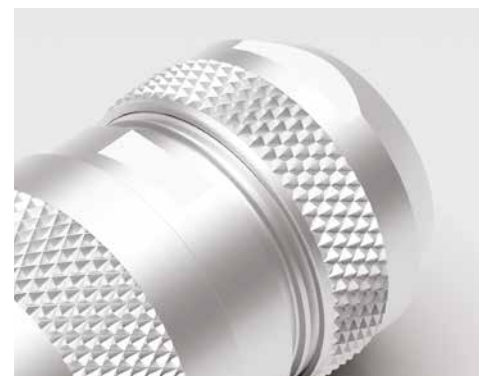

Description

Male cable connector with cable clamp, solder contacts, shieldable



Drawing

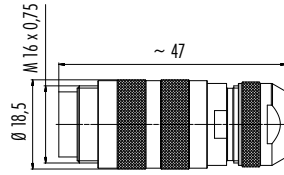

Contacts

Ordering-No.

2	99 5101 60 02
3 DIN	99 5105 60 03
4	99 5109 60 04
5	99 5113 60 05
6 DIN	99 5121 60 06
7	99 5125 60 07
8 DIN	99 5171 60 08
12	99 5129 60 12
19	99 5461 60 19

Male cable connector with cable clamp, crimp contacts, shieldable

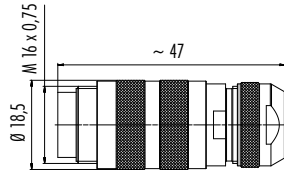

4	99 5109 760 04
5	99 5113 760 05
6 DIN	99 5121 760 06
7	99 5125 760 07
8 DIN	99 5171 760 08

Female cable connector with cable clamp, solder contacts, shieldable

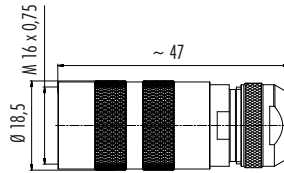

2	99 5102 60 02
3 DIN	99 5106 60 03
4	99 5110 60 04
5	99 5114 60 05
6 DIN	99 5122 60 06
7	99 5126 60 07
8 DIN	99 5172 60 08
12	99 5130 60 12
14	99 5152 60 14
19	99 5462 60 19

Female cable connector with cable clamp, crimp contacts, shieldable

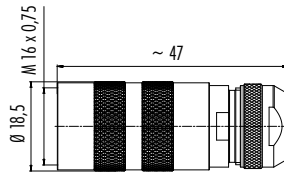

4	99 5110 760 04
5	99 5114 760 05
6 DIN	99 5122 760 06
7	99 5126 760 07
8 DIN	99 5172 760 08

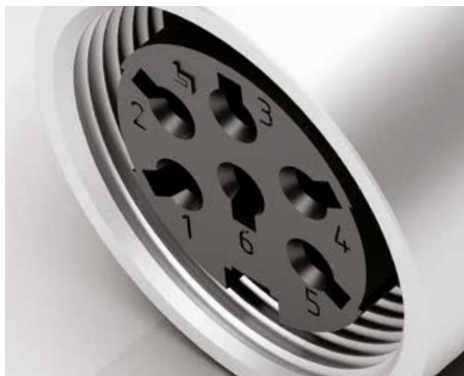

**SEN
SORS AND
ACTUA
TORS**

M8

Series	718
Contacts	5 and 6 contacts
Rated current	3 A, 1.5 A
Rated voltage	30 V
Degree of protection	IP65
Contact plating	Au (gold)
Termination	PUR cable



718 Series · Moulded snap-in cable connectors with 5 and 6 contacts

- Extension of the M8 snap-in connector programme
- Male and female cable connector moulded on cable
- Straight version
- PUR cable, PVC cable in preparation
- Standard cable length is 2 m and 5 m
- Configurable according to customer requirements
- Available

Description

Male cable connector, moulded, snap-in version, 8 mm



Drawing

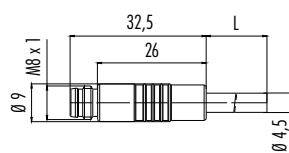

Contacts

Cable length

Ordering-No.

5	2 m	79 3413 52 05
	5 m	79 3413 55 05
6	2 m	79 3415 52 06
	5 m	79 3415 55 06

Female cable connector, moulded, snap-in version, 8 mm

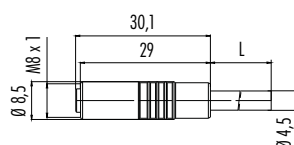

5	2 m	79 3418 52 05
	5 m	79 3418 55 05
6	2 m	79 3420 52 06
	5 m	79 3420 55 06



M8

Series	718
Contacts	3, 4, 6, 8
Rated current	4 A (3, 4 contacts) 1,5 A (6, 8 contacts)
Rated voltage	60 V (3, 4 contacts) 30 V (6, 8 contacts)
Shielding	360° shielding
Degree of protection	IP67 in mated condition
Contact plating	Au (gold)
Termination	PVC/PUR cable



718 Series • Male cable connector moulded and shielded

- Male cable connector moulded on cable
- Straight version
- PVC and PUR cable
- Standard cable length is 2 m and 5 m
- Configurable according to customer requirements
- Available

Description	Drawing	Contacts	Cable length	Ordering-No.
Male cable connector, moulded, shielded, PVC		3	2 m	77 3505 0000 20703-0200
			5 m	77 3505 0000 20703-0500
		4	2 m	77 3505 0000 20704-0200
			5 m	77 3505 0000 20704-0500
		6	2 m	77 3505 0000 20706-0200
			5 m	77 3505 0000 20706-0500
		8	2 m	77 3505 0000 20708-0200
			5 m	77 3505 0000 20708-0500
Male cable connector, moulded, shielded, PUR		3	2 m	77 3505 0000 50703-0200
			5 m	77 3505 0000 50703-0500
		4	2 m	77 3505 0000 50704-0200
			5 m	77 3505 0000 50704-0500
		6	2 m	77 3505 0000 50706-0200
			5 m	77 3505 0000 50706-0500
		8	2 m	77 3505 0000 50708-0200
			5 m	77 3505 0000 50708-0500



M12-A

Series	713
Contacts	4, 5, 8
Rated current	4 A
Rated voltage	250 V (4 contacts) 60 V (5 contacts) 30 V (8 contacts)
Shielding	360° shielding
Degree of protection	IP67 in mated condition
Contact plating	Au (gold)



713 Series • Lead-through for control cabinets

- Introduction of the lead-through for control cabinets in the new design
- For connections of signal, data and supply cables
- M12 screw and M16 fixing thread
- Easy and flexible installation
- Continuous contacts for robust and safe signal transmission
- Designed for operating temperatures from – 40 °C to + 85 °C
- Available

Description

Adapter lead-through for control cabinet, female connector M12 x 1 – male connector M12 x 1, shielded



Drawing

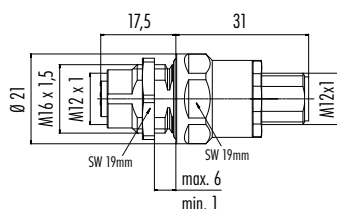

Contacts Fixing thread Ordering-No.

Contacts	Fixing thread	Ordering-No.
4	M16 x 1,5	09 5240 10 04
5		09 5241 10 05
8		09 5244 10 08

Panel cut out

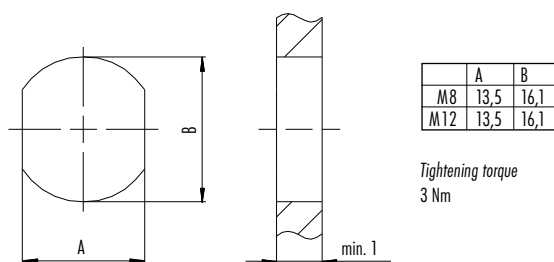



M12-A

Series	763
Contacts	4, 5, 8
Coding	A
Thread	M12
Rated current	4 A (4, 5 contacts) 2 A (8 contacts)
Rated voltage	250 V (4 contacts) 60 V (5 contacts) 30 V (8 contacts)
Degree of protection	IP69 in mated condition
Contact plating	Au (gold)
Termination	solder contacts, single wires AWG24



763 Series · M12 rectangular male panel-mount connectors 20 and 26 mm

- Portfolio extension of M12 square flange connectors with positionable and snap-in A-coding
- Two-piece square flange connector consisting of housing and contact carrier enables easy assembly
- The coding nose can be positioned in 45° steps
- Versions with 4, 5 and 8 contacts
- Available

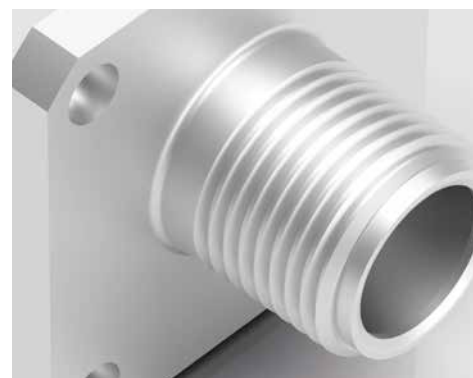

Description

Male panel-mount connector, rectangular flange, solder, positioning possible, lockable, housing 20 mm

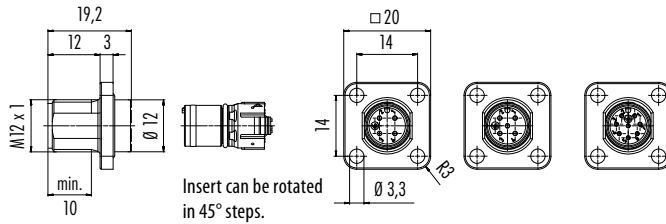

Contacts

Coding

Ordering-No.

4		99 3433 200 04
5	A	99 3443 200 05
8		99 3483 200 08

Male panel-mount connector, rectangular flange, with single wires, positioning possible, lockable, housing 26 mm

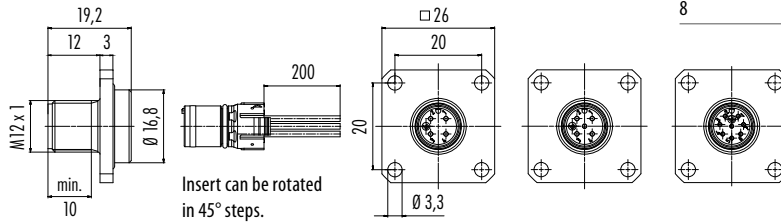

4		99 3433 116 04
5	A	99 3443 116 05
8		99 3483 116 08

Assembly instruction

Assembly:

1. Put contact insert in desired mounting position into the housing until it is securely engages.

Disassembly:

1. Press detent lever.
2. Press out the contact body simultaneously with a suitable object, from the mating side, without damaging the contacts.

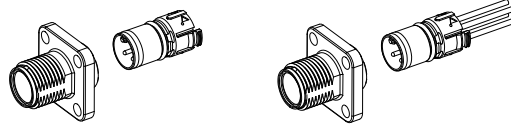

Note for contact insert with single wires:
When dismantling please do not pull the wires!

Panel cut out

Panel-mount connectors square flange

Housing 20 mm

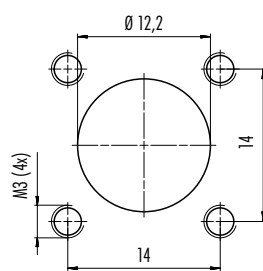

Housing 26 mm

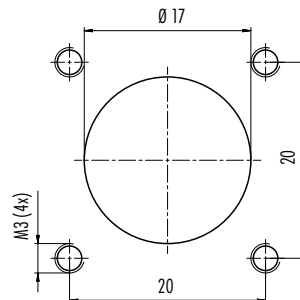

For degree of protection IP67 / IP68 / IP69:
The protection class specification applies under the requirement that the four mounting holes are designed as blind holes / screws in M3 through thread seal.



**DATA
TRANS
MISS
SION**

M8-D

Series	818
Contacts	4
Rated current	4 A
Rated voltage	63 VDC
Degree of protection	IP67 in mated condition
Contact plating	Au (gold)



818 Series · Field-attachable, moulded and panel-mount connectors

- M8-D according to IEC 61076-2-114
- Category CAT 5e
- Suitable for PoE+
- Transmission 100 Mbit/s Ethernet
- Temperature range $-25^{\circ}\text{C}/+85^{\circ}\text{C}$ (static)
- IP67 in mated condition
- Available

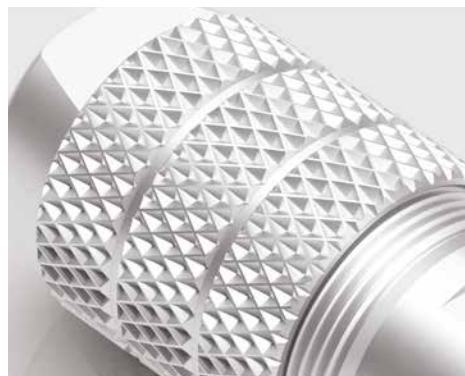

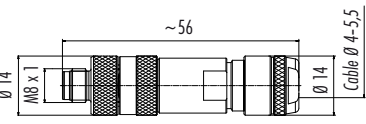
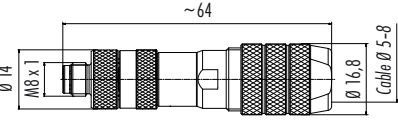
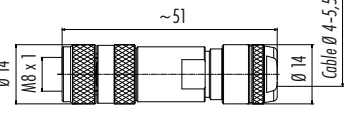
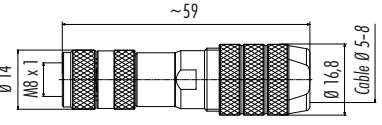
Description	Drawing	Contacts	Cable outlet	Ordering-No.
Male cable connector, screw clamp termination, iris type spring, shieldable, D-Coding		4	4-5,5 mm	99 3369 100 04
Male cable connector, screw clamp termination, iris type spring, shieldable, D-Coding		4	5-8 mm	99 3369 600 04
Female cable connector, screw clamp termination, iris type spring, shieldable, D-Coding		4	4-5,5 mm	99 3368 100 04
Female cable connector, screw clamp termination, iris type spring, shieldable, D-Coding		4	5-8 mm	99 3368 600 04

Assembly instruction

Cable outlet 4-5,5 mm

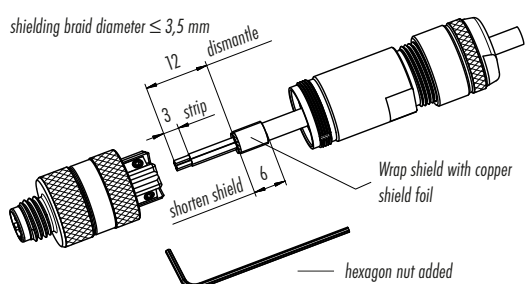
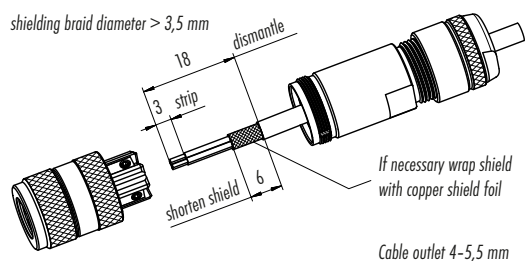

Cable outlet 5-8 mm

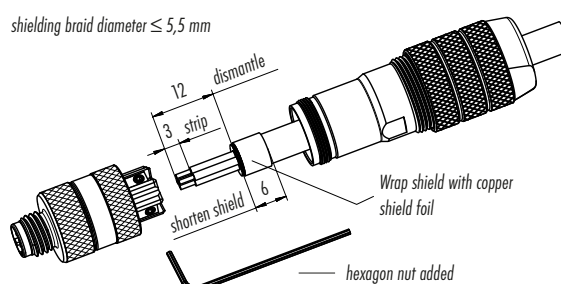
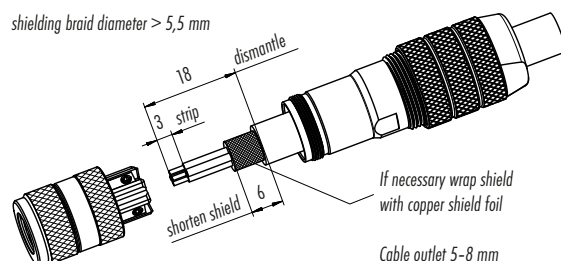

1. Bead housing to cable.
2. Strip cable, shorten shielding braid.
3. Connect single wires.
4. Screw housing to either male or female contact carrier and tighten pressing screw.

1. Bead housing to cable.
2. Strip cable, shorten shielding braid, place it over cable coating, wrap it approx. 1 1/2 times with copper shield foil and shorten foil.
3. Connect single wires.
4. Screw housing to either male or female contact carrier and tighten pressing screw.

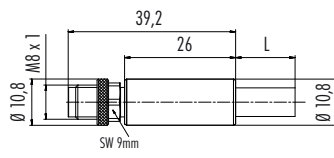
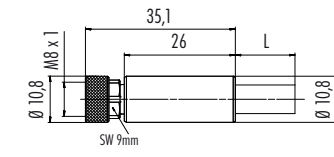
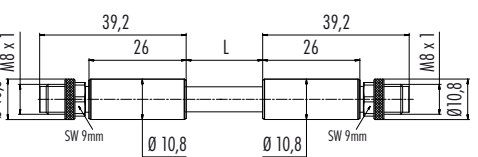
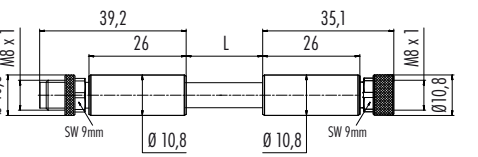
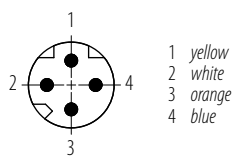
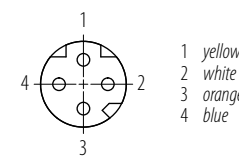
Description	Drawing	Contacts	Cable length	Ordering-No.
Male cable connector, moulded, Ethernet cable, D-Coding		4	2 m 5 m	77 5429 0000 50704-0200 77 5429 0000 50704-0500
Female cable connector, moulded, Ethernet cable, D-Coding		4	2 m 5 m	77 5430 0000 50704-0200 77 5430 0000 50704-0500
Male cable connector M8 x 1 – Male cable connector M8 x 1, D-Coding		4	1 m 2 m	77 5429 5429 50704-0100 77 5429 5429 50704-0200
Male cable connector M8 x 1 – Female cable connector M8 x 1, D-Coding		4	1 m 2 m	77 5430 5429 50704-0100 77 5430 5429 50704-0200
Contact arrangements	<p data-bbox="295 1482 422 1518">male insert (mating side)</p> 	<p data-bbox="885 1482 1013 1518">female insert (mating side)</p> 		
Specifications	Ethernet Cable			
Contacts	4			
Wire gauge mm ²	4 x AWG 22			
Material jacket	PUR			
Insulation of wire	Polyolefin			
Design of wire (mm)	7 x AWG 22			
Cable diameter (mm)	6,7			
Resistance of wire	55 Ω/Km (20 °C)			
Temperature range cable in move	- 20 °C /+ 60 °C			
Temperature range cable fixed	- 40 °C /+ 80 °C			
Bending radius cable in move	min. 15 x d			
Bending radius cable fixed	min. 5 x d			
Bending radius (at 10 x D)	2 Mio.			
Permitted acceleration	2 m/s ²			
Traverse path horizontal 5 m/s ²	5 m			
Traverse path vertical 5 m/s ²	5 m			
Traverse speed	At 5 m horizontal traverse up to 200 m/min			
Approval	PROFINET, UL/CSA			

Description

Male panel-mount connector, front fastened, dip solder, with shielding sheet, D-Coding

Drawing

Contacts

Ordering-No.

4

86 6321 1120 00404

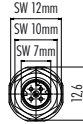
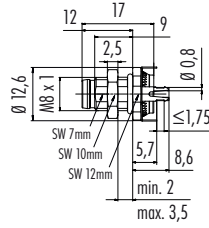

Thickness of PCB: $\le 1,75$ mm
Hexagon nut enclosed loose

Male angled panel-mount connector, front fastened, dip solder, with shielding sheet, D-Coding

4

86 6321 1121 00404

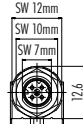
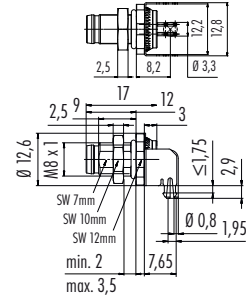

Thickness of PCB: $\le 1,75$ mm
Hexagon nut enclosed loose

Female panel-mount connector, front fastened, dip solder, with shielding sheet, D-Coding

4

86 6620 1120 00404

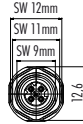
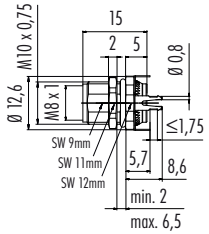

Thickness of PCB: $\le 1,75$ mm
Hexagon nut enclosed loose

Female angled panel-mount connector, front fastened, dip solder, with shielding sheet, D-Coding

4

86 6620 1121 00404

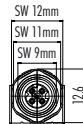
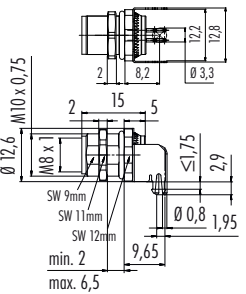

Thickness of PCB: $\le 1,75$ mm
Hexagon nut enclosed loose

Drilling schemes

male insert (PCB), shielding sheet

female insert (PCB), shielding sheet

4 contacts

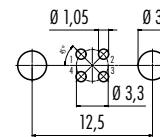
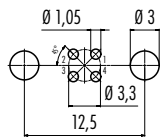

Panel cut out

With flats as anti-rotation device

With bore hole

With thread to screw in

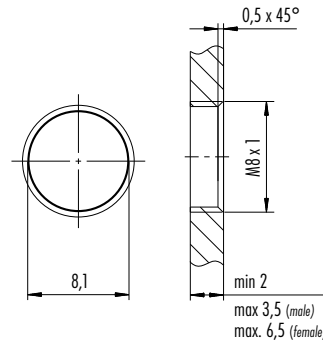
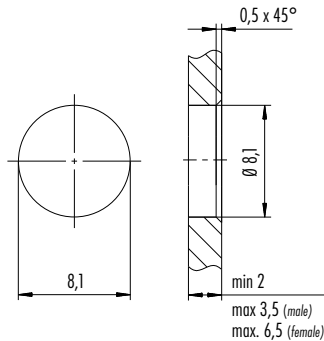
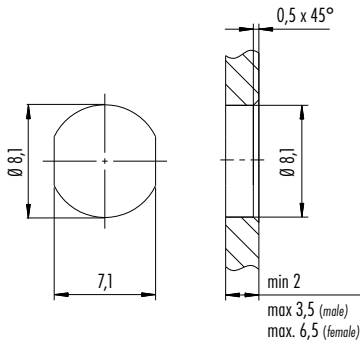

Tightening moment

Metal housing 1 Nm
Plastic housing 1 Nm

**VOLL
TAGGE
AND POWER
SUPPLY**

M12-S, -K, -T, -L

Series	814, 824, 813, 823
Contacts	2+PE, 3+PE, 4+PE, 4, 4+FE
Rated current	12 A, 16 A
Rated voltage	630 V (S-/K-Coding) 63 V (T-/L-Coding)
Shielding	360° shielding
Degree of protection	IP67 in mated condition
Contact plating	Au (gold)



814, 824, 813, 823 Series · Lead-through for control cabinets

- Introduction of the lead-through for control cabinets in the new design
- Enables the connection of signal, data and supply cables
- M12 screw and M16 fixing thread
- Easy and flexible installation
- Continuous contacts for robust and safe signal transmission
- Designed for operating temperatures from – 40 °C to + 85 °C
- Available



Description

M12-S
 Adapter lead-through for control cabinet,
 female connector M12 x 1 – male connector M12 x 1,
 shielded

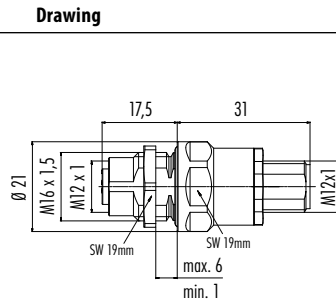

Contacts	Fixing thread	Ordering-No.
2+PE	M16 x 1,5	09 5270 10 03
3+PE		09 5271 10 04

M12-K
 Adapter lead-through for control cabinet,
 female connector M12 x 1 – male connector M12 x 1,
 shielded

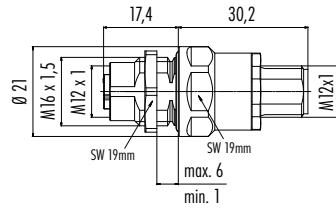

4+PE	M16 x 1,5	09 5290 10 05
------	-----------	---------------

M12-T
 Adapter lead-through for control cabinet,
 female connector M12 x 1 – male connector M12 x 1,
 shielded

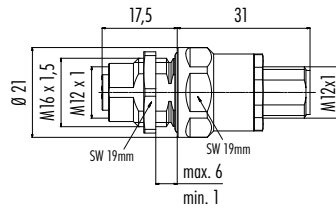

4	M16 x 1,5	09 5260 10 04
---	-----------	---------------

M12-L
 Adapter lead-through for control cabinet,
 female connector M12 x 1 – male connector M12 x 1,
 shielded

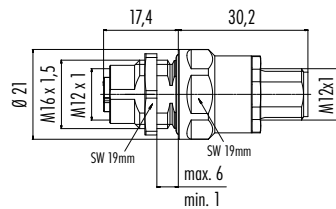

4+FE	M16 x 1,5	09 5291 10 05
------	-----------	---------------

Panel cut out

Lead-through for control cabinet with bore hole

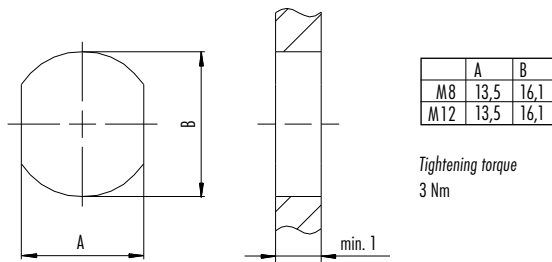

M12-K/-L

Series	824, 823
Contacts	4+PE, 4+FE
Coding	K, L
Thread	M12 x 1
Rated current	12 A, 16 A
Rated voltage	630 V AC, 63 V DC
Degree of protection	IP67
Contact plating	Au (gold)

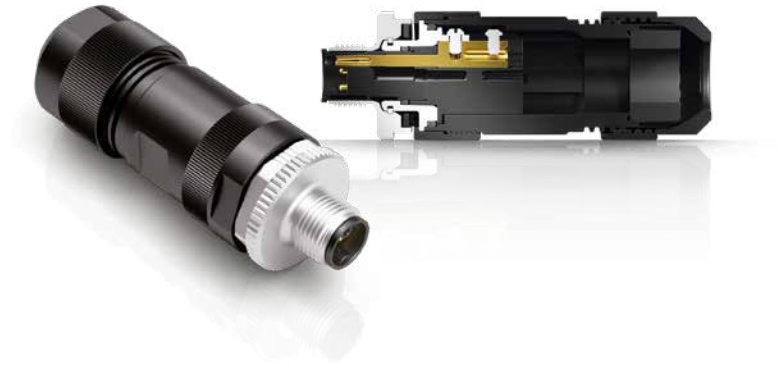

824/823 Series · M12 K- & L-coded cable connectors acc. to UL 2237

- Screw clamp connection
- Cable outlet up to 13 mm
- PE connection to the threaded ring
- UL 2237 achievable
- K-coded: 4+PE, current 12 A, voltage 630 V AC
- L-coded: 4+FE, current 16 A, voltage 63 V DC
- Available



Description

Male cable connector with **K-Coding**, screw clamp connection, Power

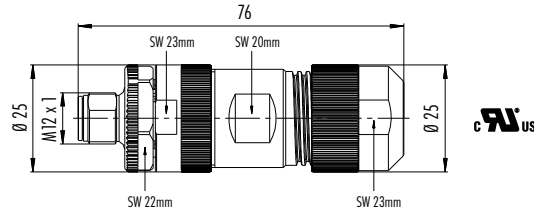

Contacts	Coding	Cable outlet	Ordering-No.
4+PE	K	8-13 mm	99 0699 370 05

Male angled connector with **K-Coding**, screw clamp connection, Power

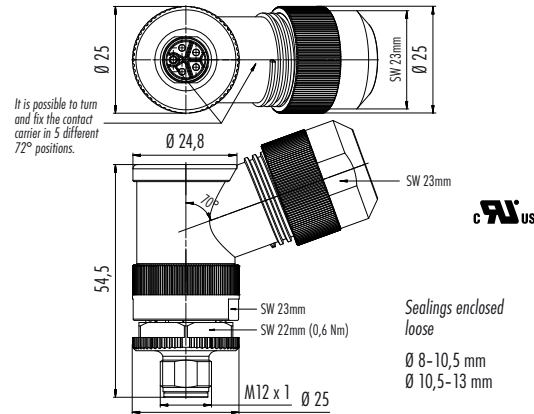

4+PE	K	8-13 mm	99 0699 370 05
------	---	---------	----------------

Female cable connector with **K-Coding**, screw clamp connection, Power

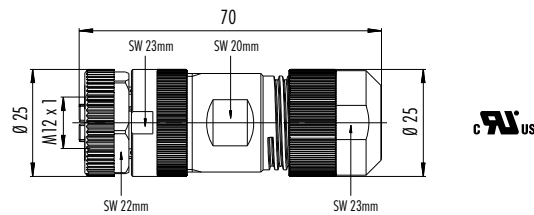

4+PE	K	8-13 mm	99 0700 370 05
------	---	---------	----------------

Female angled connector with **K-Coding**, screw clamp connection, Power

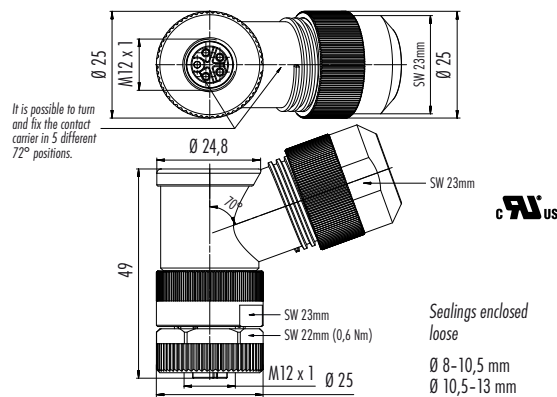

4+PE	K	8-13 mm	99 0700 370 05
------	---	---------	----------------

Description

Male cable connector with **L-Coding**, screw clamp connection, Power



Drawing

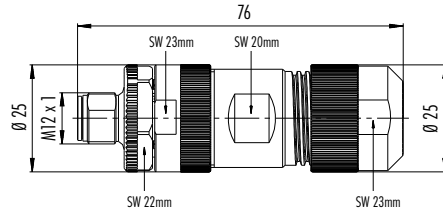

Contacts

Coding

Cable outlet

Ordering-No.

4+FE

L

8-13 mm

99 0639 37 05

Male angled connector with **L-Coding**, screw clamp connection, Power

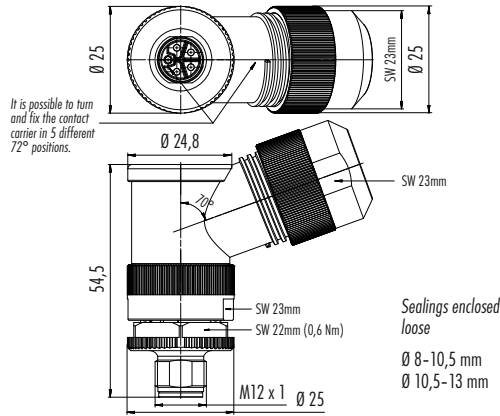

4+FE

L

8-13 mm

99 0639 37 05

Female cable connector with **L-Coding**, screw clamp connection, Power

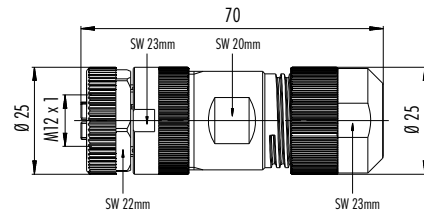

4+FE

L

8-13 mm

99 0640 37 05

Female angled connector with **L-Coding**, screw clamp connection, Power

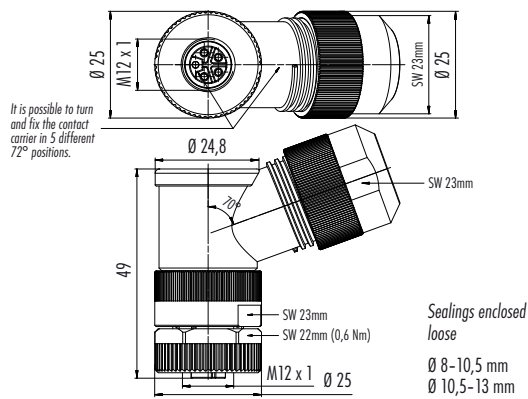

4+FE

L

8-13 mm

99 0640 37 05

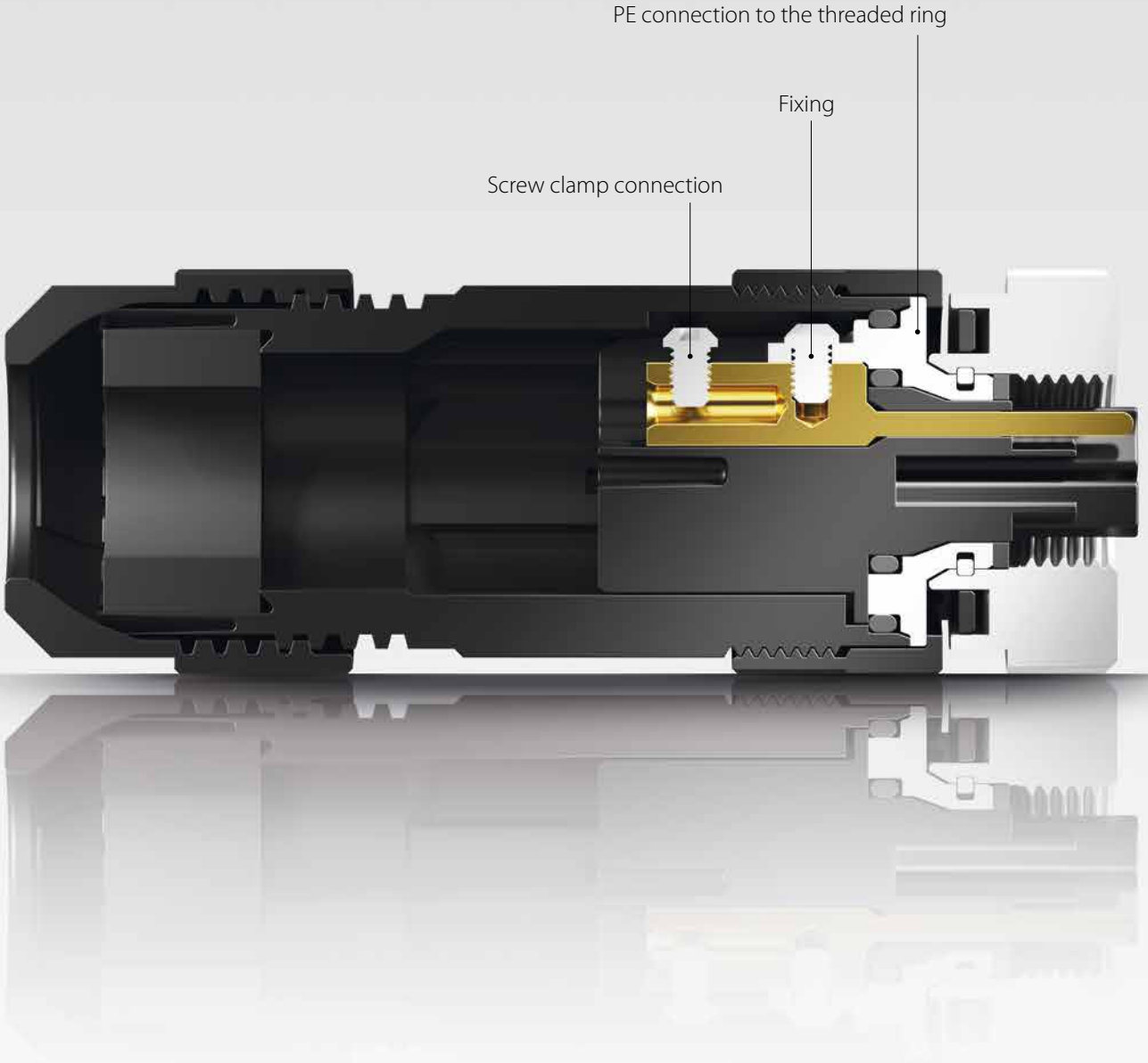

PE connection to the threaded ring

Fixing

Screw clamp connection

M12-L

Series	823
Contacts	4+FE
Coding	L
Thread	M12 x 1
Rated current	16 A
Rated voltage	63 V DC
Degree of protection	IP68 in mated condition
Contact plating	Au (gold)



823 Series • M12 L-Coded panel-mount connectors two-part design

- Dip solder contacts
- 16 A, 63 V
- Front and rear fastening
- Contact insert and panel-mount housing have no permanent connection
- Grey contact body
- Contacts with gold surface
- Suitable for reflow soldering
- Available



Description	Drawing	Contacts	Fixing thread	Ordering-No.
-------------	---------	----------	---------------	--------------

Male panel-mount connector, two-part design, Power, L-coding

4+FE M16 x 1,5 99 0641 20 05

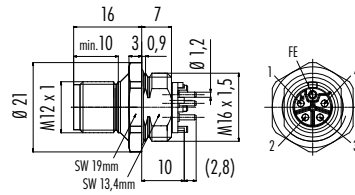

Male panel-mount connector, front fastened, two-part design, Power, L-coding

4+FE M16 x 1,5 99 0641 10 05

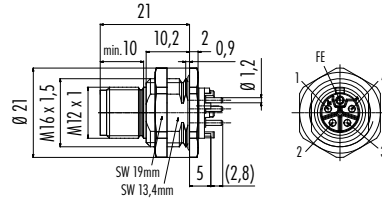

Female panel-mount connector, two-part design, Power, L-coding

4+FE M16 x 1,5 99 0642 20 05

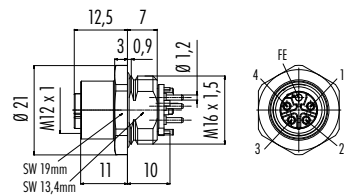

Female panel-mount connector, front fastened, two-part design, Power, L-coding

4+FE M16 x 1,5 99 0642 10 05

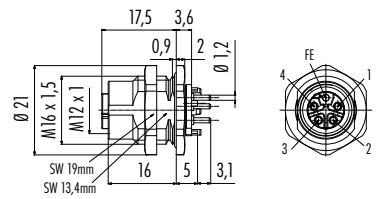

Drilling schemes

male insert (PCB), shielding sheet

female insert (PCB), shielding sheet

4 contacts

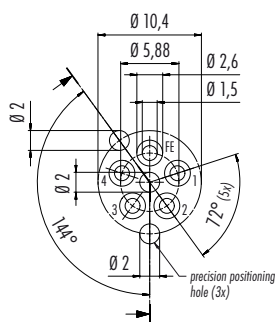

	X	Y
FE	0,00	2,94
1	2,80	0,91
2	1,73	-2,38
3	-1,73	-2,38
4	-2,80	0,91
Pos.	0,00	0,00
Pos.	0,00	-5,2
Pos.	-3,06	4,21

min. 0,8

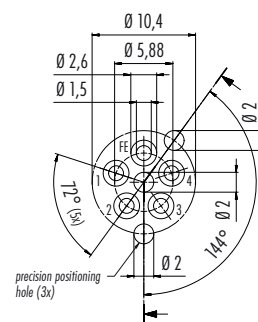

	X	Y
FE	0,00	2,94
1	-2,80	0,91
2	-1,73	-2,38
3	1,73	-2,38
4	2,80	0,91
Pos.	0,00	0,00
Pos.	0,00	-5,2
Pos.	3,06	4,21

min. 0,8

Panel cut out

Panel-mount connectors

With flats as anti-rotation device

With bore hole

Rear mounting

With thread to screw in

Front mounting

With thread to screw in

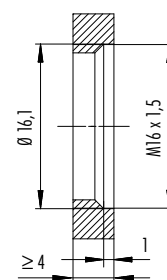
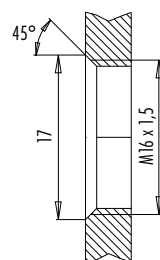
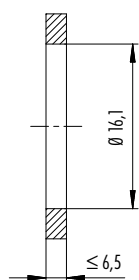
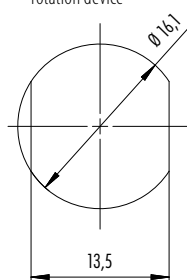

← Screw-in direction panel-mount part

Tightening moment

Metal housing 1,25 Nm
Plastic housing 1,25 Nm



E. HARTNER & CO

Triester Straße 190, 1230 Wien, Austria

<https://www.ehartner.at/>

Office: office@ehartner.at +43 1 914 43 96 **D, EN, CZ**

Marion Essl: m.essl@ehartner.at +43 664 5438529 **D, EN**

Jeno Szabo: j.szabo@ehartner.at +36 20 33 91 589 **H, EN**

Franz Binder GmbH & Co.
Elektrische Bauelemente KG

Rötzelstraße 27
74172 Neckarsulm
Germany

Tel. +49 7132 325-0
Fax +49 7132 325-190

vk@binder-connector.de
www.binder-connector.de

07/2023

